

Rigid
— FLOORS
& WALLS

by lalegno 



FLOORS &
— WALLS
WITH
STYLE

COLLECTION

ALL ABOUT — Rigid

CONSTRUCTION SPC - OPBOUW SPC

- Extra Matt PU topcoat + Aluminium Oxide for anti scratch. Durable surface protection that is easy to clean.
- Couche de finition PU extra-mate + oxyde d'aluminium pour une protection anti-rayures. Protection de surface durable et facile à nettoyer.
- Extra matte PU-toplaag + aluminiumoxide tegen krassen. Duurzame bescherming van het oppervlak én makkelijk schoon te maken.

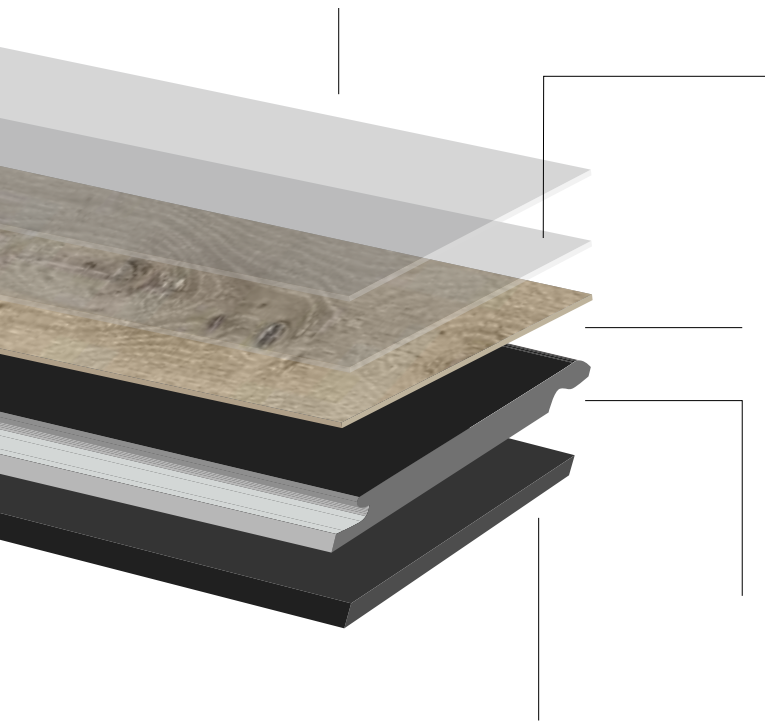

- Durable transparent wearlayer
Preserve the authentic colour and embossing, protecting from abrasion.
- Couche d'usure transparente durable.
Préserver la couleur et l'embossage authentiques, avec protection contre l'abrasion.
- Duurzame transparante slijtlaag.
Behouden de authentieke kleur en het reliëf, en bescherm tegelijk tegen slijtage.
- High quality decor film.
- Film décoratif de haute qualité.
- Decorfilm van hoge kwaliteit.

- Latest SPC (Stone Powder Composite) technology
Ultra strong Rigid core. The SPC core is made by combining limestone powder and stabilizers to create a dimensionally stable and waterproof core. Contains no heavy metals or formaldehyde nor any other harmful substances and is 100% environmental flooring.
- Dernière technologie SPC (Stone Powder Composite) à âme rigide ultrarésistante. Le noyau SPC est fabriquée en combinant de la poudre de calcaire et des stabilisateurs pour créer une âme dimensionnellement stable et imperméable. Ne contient ni métaux lourds, ni formaldéhyde, ni aucune autre substance nocive et constitue un revêtement de sol 100 % écologique.
- Ultrasterke Rigid-kern met de nieuwste SPC-technologie (Stone Powder Composite). Voor SPC wordt kalksteenpoeder gemengd met stabilisatoren om een waterbestendige kern met een uitstekende dimensionele stabiliteit te bekomen. Bevat geen zware metalen of formaldehyde, noch andere schadelijke stoffen, en is een 100% milieuvriendelijke vloerbekleding.

Planks & tiles:

- 1 mm IXPE underlay linked to core layer.
Better sound absorption and excellent feeling while walking on the floor.

Planches et dalles :

- Sous-couche IXPE de 1 mm liée à la couche centrale. Meilleure absorption acoustique et excellente sensation en marchant sur le sol.

Planken en tegels:

- 1 mm IXPE-onderlaag verbonden met de kernlaag. Absorbeert het geluid beter en voelt heerlijk aan wanneer u op de vloer loopt.

01.

10 ADVANTAGES

AVANTAGES - VOORDELEN

5

02.

RIGID — FLOORS

PLANCHES ET CARRELAGES - PLANKEN EN TEGELS

17

03.

RIGID — WALLS

REVÊTEMENT MURAL - WANDPANELEN

46

04.

ACCESSORIES

ACCESSOIRES

69

05.

TECHNICAL — INFO

FICHE TECHNIQUE - TECHNISCHE FICHE

74



RIGID FLOORS & WALLS — 10 ADVANTAGES

AVANTAGES - VOORDELEN



1. SCRATCH & SHOCK RESISTANT

Our SPC is sealed with a coating in aluminium oxide, a natural mineral with very high durability. This extra protective layer ensures that your floor will not scratch easily.

Notre SPC sont scellés avec une couche protectrice en oxyde d'aluminium, un minéral naturel d'une très grande durabilité. Cette couche de protection supplémentaire garantit que votre sol ne se rayera pas facilement.

Onze SPC is voorzien van een coating in aluminiumoxide, een natuurlijk mineraal met een heel hoge duurzaamheid. Die extra beschermlaag zorgt ervoor dat je veel minder snel krassen krijgt.



2. WATER RESISTANT

The wood in hardwood flooring or laminate can be damaged by excessive contact with water. With our SPC floors, you don't have to worry about that! Every fibre of quality material from Rigid Floors is completely water-repellent.

Le bois du parquet ou du stratifié peut être endommagé par un contact excessif avec l'eau. Pas nos parois SPC! Chaque matériau de qualité de fibre « Rigid Wall » est résistant à l'eau.

Het hout in parket of laminaat kan beschadigd raken door overvloedig contact met water. Onze SPC-vloeren niet! Elke vezel kwaliteitsmateriaal van Rigid Floors is waterwerend.

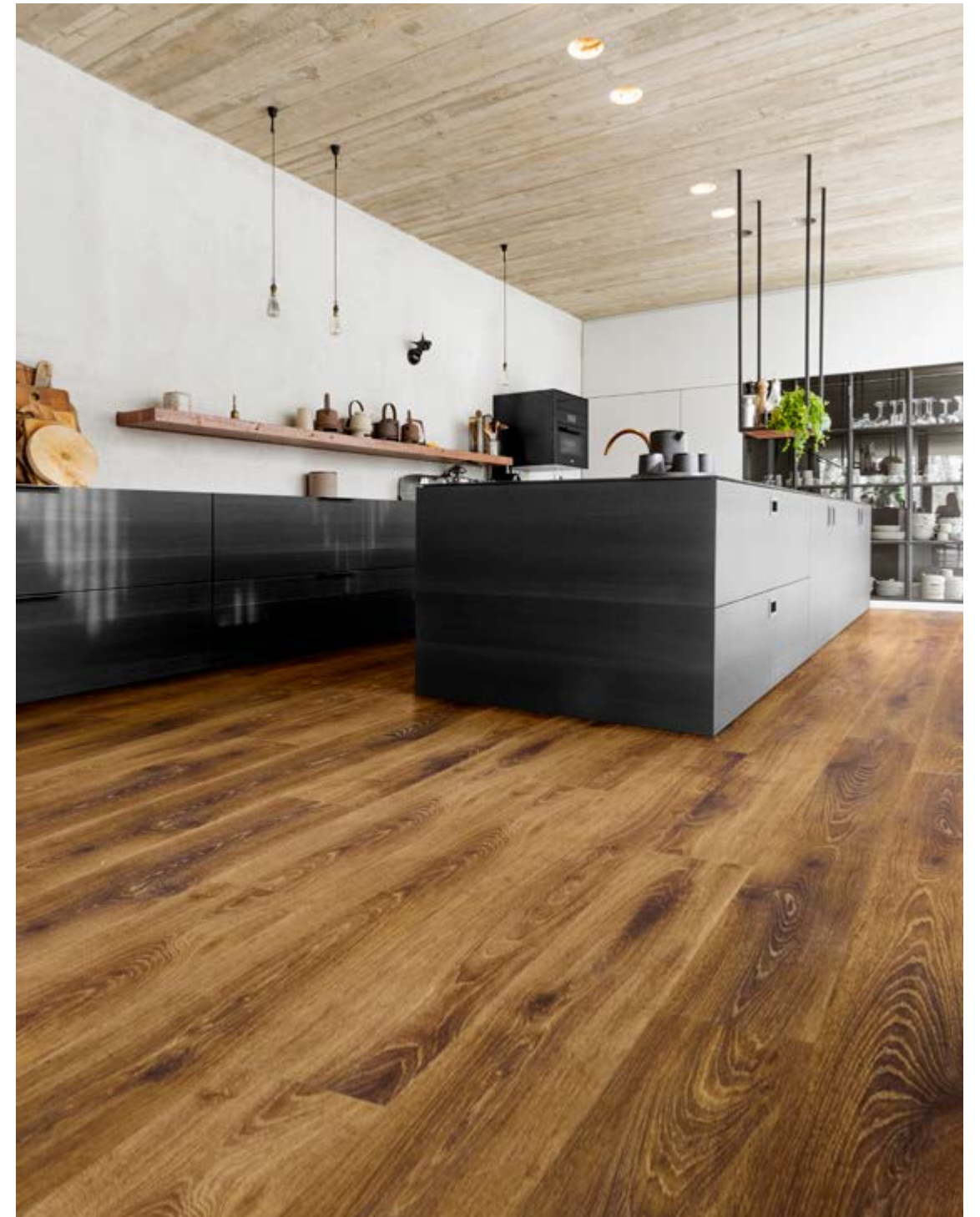

JESI

3. REALISTIC LOOK

Texture and prints are a natural duo. Our SPC planks are embossed in register (EIR) and our SPC tiles are travertine embossed, which makes it almost indistinguishable from real wood or stone.

Relief et impression, un duo naturel. Nos planches en EIR-embossed et carrelages en travertine-embossed sont presque impossible à distinguer du bois ou de la pierre, grâce à cette structure de surface naturelle.

Reliëf en print, een natuurlijk duo. Onze EIR-embossed SPC-planken en travertine embossed SPC -tegels en zijn dankzij deze natuurgetrouwe oppervlaktestructuur bijna niet meer van echt hout of steen te onderscheiden.



EMBOSSSED IN REGISTER (EIR)

BARBARESCO



TRAVERTINE EMBOSSSED

SANOMA

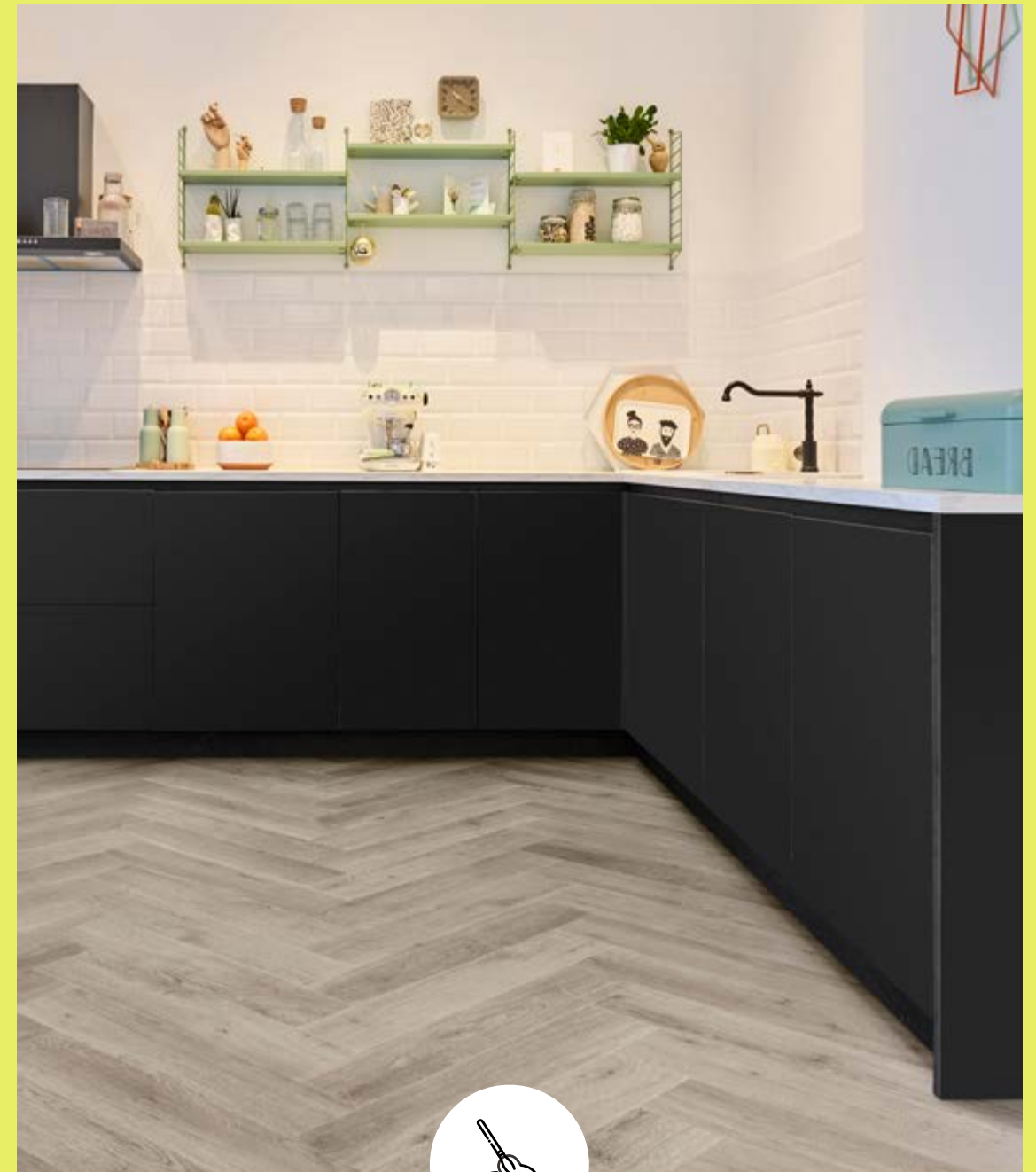

LIMONCELLO - HERRINGBONE

4. EASY TO MAINTAIN

Every Rigid Floor & Wall has a durable end wear layer that protects the floor throughout its life from penetrating stains.

Elke Rigid Floor & Wall krijgt een duurzame eindslijtlaag die de vloer zijn leven lang beschermt tegen indringende vlekken.

Chaque Rigid Floor & Wall est pourvu d'une couche d'usure durable qui protège le sol tout au long de sa vie contre les taches pénétrantes.



MONTALCINO



5. HIGHLY EFFICIENT ACOUSTICS

Rigid Floors have an integrated and well-insulating backing that absorbs sound. So no more hollow thud sounds as when walking on laminate floors.

Rigid Floors ont une sous-couche intégrée et bien isolante qui absorbe le son. Vous n'auriez pas le bruit creux comme lorsque vous marchiez sur un sol stratifié.

Rigid Floors hebben een geïntegreerde en goed isolerende onderlaag die geluid absorbeert. Gedaan dus met het holle geluid van laminaatvloeren.



6. PLEASANT TO THE FEET

Rigid Floors have anti-slip properties that are much better than most other floor coverings, whatever footwear you own. An additional advantage, our SPC floors never feel cold.

Quelles que soient vos chaussures, Rigid Floors ont des propriétés antidérapantes bien meilleures que la plupart d'autres revêtements de sol. Un avantage supplémentaire, nos sols SPC ne sont jamais froids.

Welk schoeisel je ook draagt, de antislip-eigenschappen van Rigid Floors zijn veel beter dan die van de meeste andere vloerbedekkingen. Een extra voordeel, onze SPC vloeren voelen ook nooit koud aan.



GUBBIO

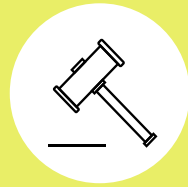

7. EASY TO INSTALL

Our SPC floors are provided of a G5-click system that simply click into place, which makes it easy and quick to install. Our SPC wall panels are provided of a tongue and groove system. They are glued to the wall to achieve maximum strength and security.

Nos sols SPC sont équipés d'un système de G5-clic qui s'enclenche simplement, ce qui le rend facile et rapide à installer. Nos panneaux muraux SPC sont dotés d'un système à rainure et languette. L'encollage au mur vous garantira une sécurité et une solidité maximales.

Onze SPC-vloeren zijn voorzien van een G5-kliksysteem dat eenvoudig vastklikt, waardoor ze eenvoudig en snel te plaatsen zijn. Onze SPC wandpanelen zijn voorzien van een tand- en groefstelsel. Ze worden aan de muur gelijmd om maximale sterkte en veiligheid te bereiken.



RIGID FLOORS - WITH CLICK SYSTEM



RIGID WALL - WITH T&G SYSTEM

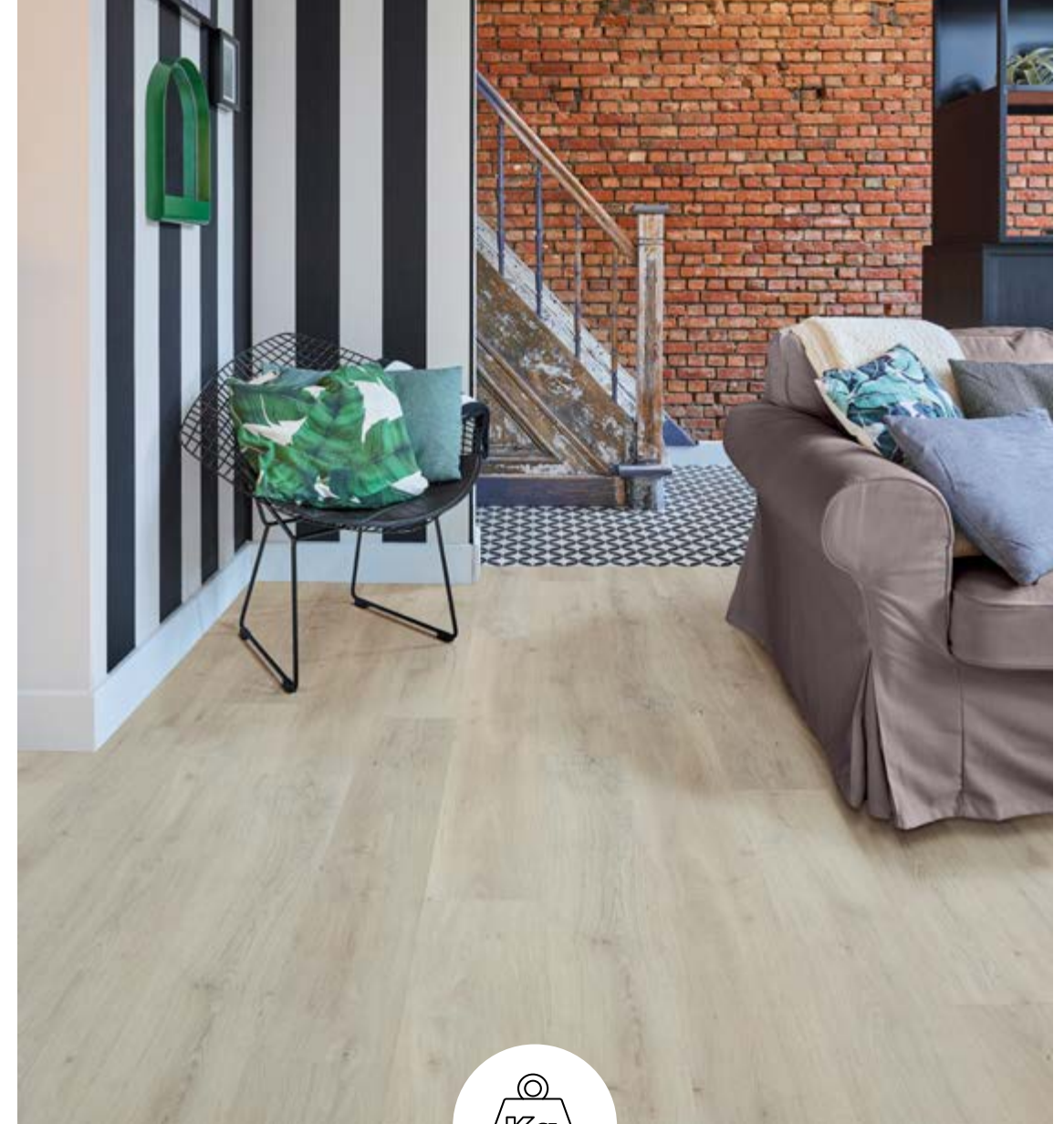
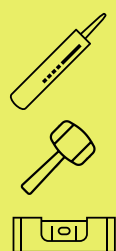

BAROLO



8. STRONG & HIGH STABILITY

The core layer of our SPC consists of limestone and PVC, which makes the floor extra strong and stable. This type of floor is therefore also ideal for intensively used spaces.

De kernlaag van onze SPC bestaat uit kalksteen en PVC, dit maakt de vloer extra sterk en stabiel. Dit type vloeren is hierdoor dus ook ideaal voor intensief gebruikte ruimtes.

La couche centrale de nos SPC est composée de calcaire et de PVC, ce qui rend le sol extrêmement solide et stable. Ce type de sol est donc également idéal pour les espaces intensivement utilisés.

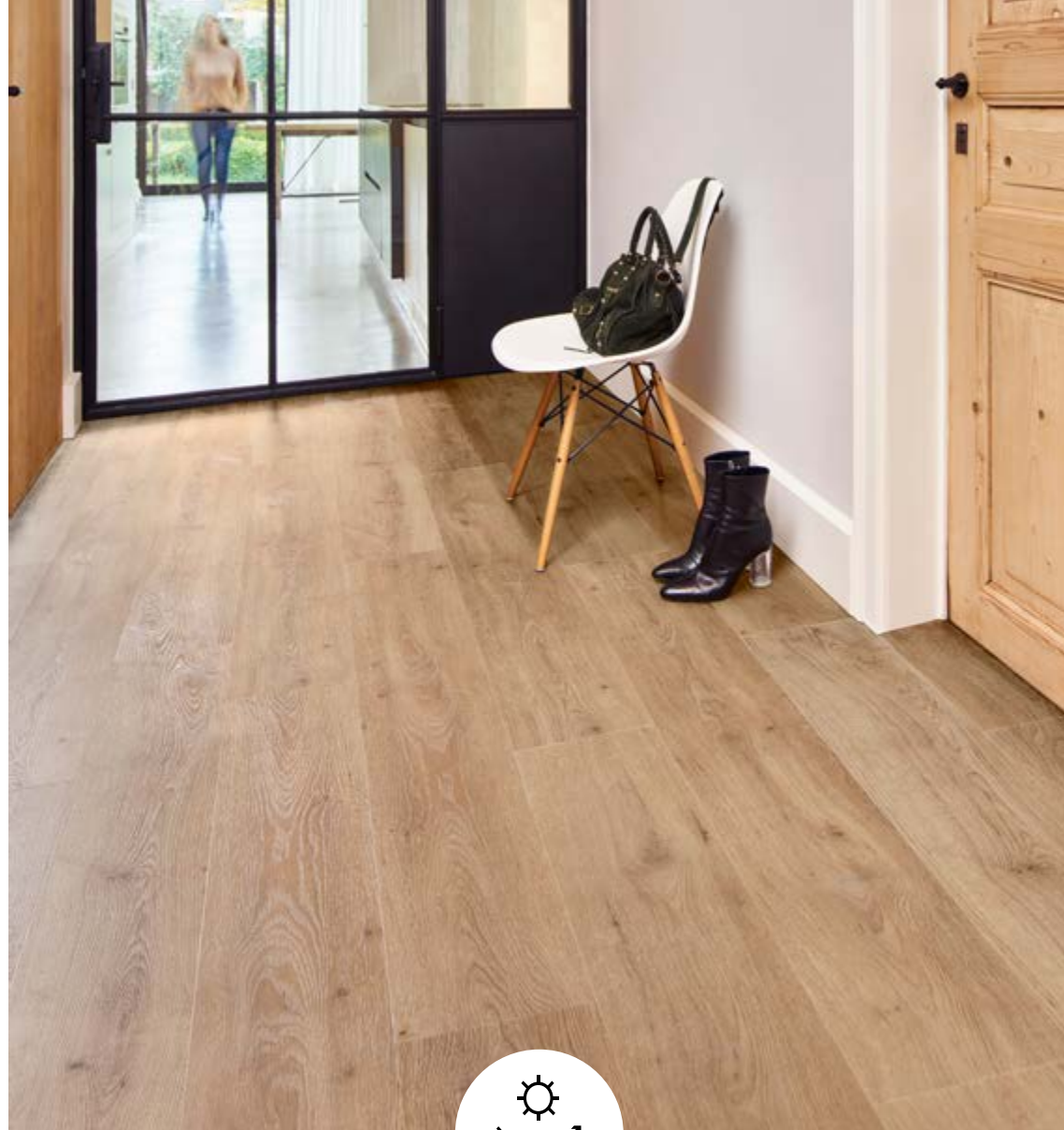

PALERMO



9. UV RESISTANT

Rigid Floors & Walls were given optimum UV protection, so that the original colour of your SPC floor is optimally preserved for a long time and you do not have to worry about important colour differences.

Rigid Floors & Walls ont obtenu une protection optimale contre les rayons UV, de sorte que la couleur d'origine de votre sol SPC soit préservée de manière parfaite pendant très longtemps et que vous n'ayez pas à vous soucier des différences de couleur importantes.



10. ANTI-ALLERGENIC-FREE FROM HARMFUL SUBSTANCES

Rigid Floors and Wall do not contain formaldehyde or other harmful substances. Our SPC have no negative influence on the healthy air quality of your home.

Rigid Floors en Wall bevatten geen formaldehyde of andere schadelijke stoffen. Onze SPC hebben geen negatieve invloed op de gezonde luchtkwaliteit van je woning.

Rigid Floors et Wall ne contiennent pas de formaldéhyde ni d'autres substances nocives. Nos SPC n'ont aucune influence négative sur la qualité d'air sain dans votre maison.

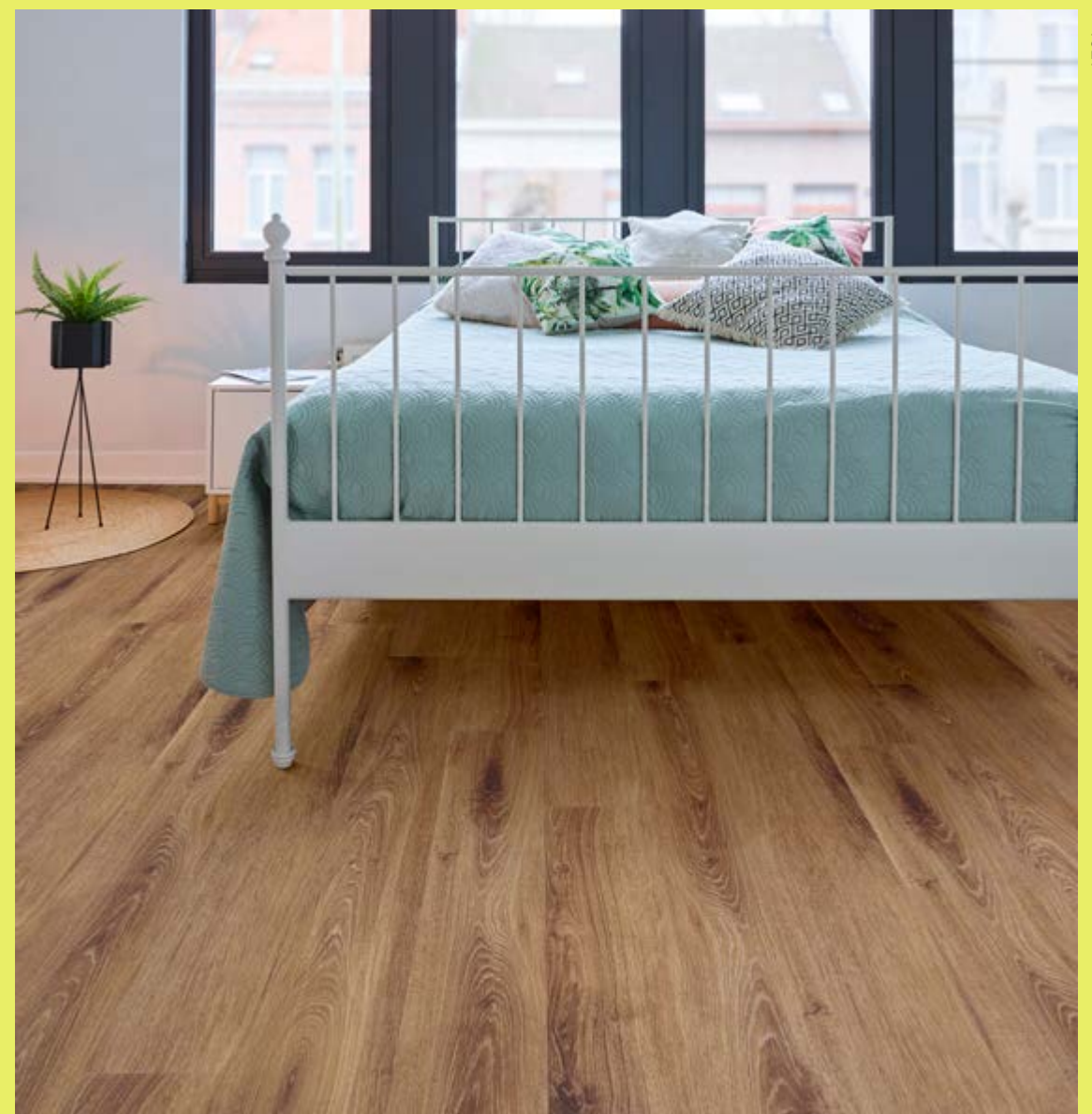

JESI

Rigid VINYL — PLANKS

8 MM PLANKS - HIGH END

Rigid VINYL — PLANKS

8 MM - HIGH END

PERUGIA



Total thickness of 8 mm - Wear layer of 0.70 mm and 2 mm cork integrated backing.

Extra wide and long.

Dimensions: 225 x 1830 mm - Grade: prime look.

Épaisseur totale de 8 mm - Couche d'usure de 0.70 mm - Sous-couche intégrée en liège de 2 mm. - **Extra large et long.**

Dimensions: 225 x 1830 mm - Classe: prime look.

Totale dikte van 8 mm - Slijtlaag van 0.70 mm. Geïntegreerde onderlaag van 2 mm kurk.

Extra breed en lang.

Afmeting: 225 x 1830 mm - Sortering: prime look.

ANCONA



ANCONA

Rigid VINYL — PLANKS

6,50 MM PLANKS

Rigid VINYL — PLANKS

6,50 MM - PRIME GRADE LOOK

LIMONCELLO



Total thickness of 6.50 mm - Wear layer of 0.70 mm and integrated backing.
Dimensions: 180 x 1220 mm - Grade: prime look.

Épaisseur totale de 6.50 mm - Couche d'usure de 0.70 mm et sous-couche intégrée.
Dimensions: 180 x 1220 mm - Classe: prime look.

MONTALCINO



Totale dikte van 6.50 mm - Slijtlaag van 0.70 mm en geïntegreerde ondervloer.
Afmeting: 180 x 1220 mm - Sortering: prime look.

AREZZO



GUBBIO



MONTALCINO

VENETO



PALERMO



BARBARESCO



BAROLO





VENETO



AREZZO

REAL EMBOSSED PRIME LOOK

EMBOSSED IN REGISTER (EIR)



GUBBIO



GUBBIO - HERRINGBONE

AREZZO - HERRINGBONE

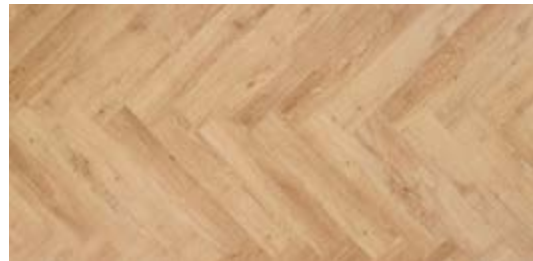

Total thickness of 6.50 mm - Wear layer of 0.70 mm and integrated backing.
Dimensions: 600 x 120 mm - Grade: prime look.

Épaisseur totale de 6.50 mm - Couche d'usure de 0.70 mm et sous-couché intégrée.
Dimensions: 600 x 120 mm - Classe: prime look.

Totale dikte van 6.50 mm - Slijtlaag van 0.70 mm en geïntegreerde ondervloer.
Afmeting: 600 x 120 mm - Sortering: prime look.

BARBARESCO - HERRINGBONE

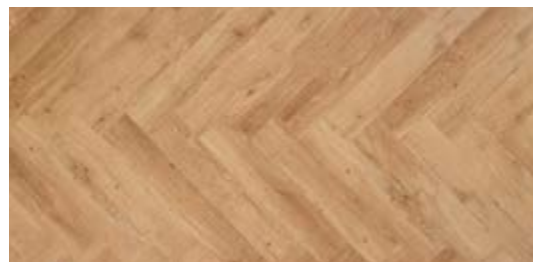

PALERMO - HERRINGBONE



GUBBIO - HERRINGBONE

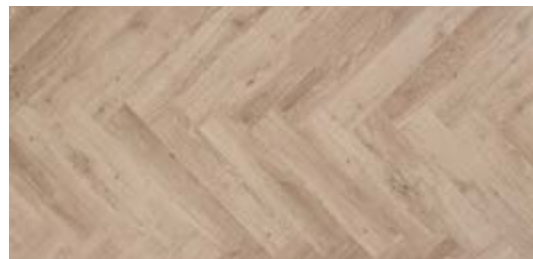

LIMONCELLO - HERRINGBONE

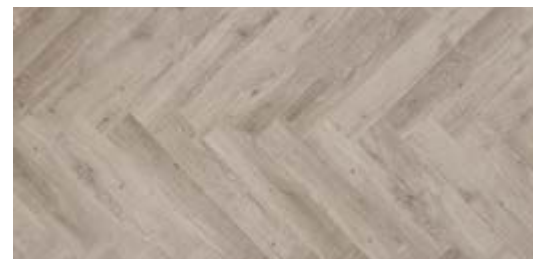

AREZZO - HERRINGBONE



JESI



JESI

CORTESE



REAL EMBOSSED RUSTIC LOOK

EMBOSSED IN REGISTER (EIR)

Rigid VINYL — PLANKS

6,50 MM - RUSTIC GRADE LOOK

CORTESE



Total thickness of 6.50 mm - Wear layer of 0.70 mm and integrated backing.
Dimensions: 180 x 1524 mm - Grade: rustic look.

Épaisseur totale de 6.50 mm - Couche d'usure de 0.70 mm et sous-couche intégrée.
Dimensions: 180 x 1524 mm - Classe: aspect look rustique.

Totale dikte van 6.50 mm - Slijtlaag van 0.70 mm en geïntegreerde ondervloer.
Afmeting: 180 x 1524 mm - Sortering: rustieke look.

JESI



CORTESE

Rigid VINYL — PLANKS

5 MM PLANKS

Rigid VINYL — PLANKS

5 MM - PRIME GRADE LOOK

INVISIBLE



Total thickness of 5 mm - Wear layer of 0.55 mm and integrated backing.

Dimensions: 180 x 1220 mm - Grade: prime look.

Épaisseur totale de 5 mm - Couche d'usure de 0.55 mm et sous-couche intégrée.

Dimensions: 180 x 1220 mm - Classe: prime look.

Totale dikte van 5 mm - Slijtlaag van 0.55 mm en geïntegreerde ondervloer.

Afmeting: 180 x 1220 mm - Sortering: prime look.

NATURAL



GREY



OAK



FUME



GREY

Rigid FLOORS — DRYBACK

2,50 MM PLANKS

Rigid FLOORS — DRYBACK

2,50 MM - PRIME GRADE LOOK

LIMONCELLO - DRYBACK



Total thickness of 2.50 mm.
Wear layer of 0.55 mm and glue down.
Dimensions: 184 x 1219 mm - Grade: prime look.

Épaisseur totale de 2.50 mm.
Couche d'usure de 0.55 mm et coller.
Dimensions: 184 x 1219 mm - Classe: prime look.

Totale dikte van 2.50 mm.
Slijtlaag van 0.55 mm en vastlijmen.
Afmeting: 184 x 1219 mm - Sortering: prime look.

MONTALCINO - DRYBACK



AREZZO - DRYBACK



GUBBIO - DRYBACK



PALERMO - DRYBACK

VENETO - DRYBACK



PALERMO - DRYBACK



BARBARESCO - DRYBACK



BAROLO - DRYBACK



Rigid VINYL — TILES

7 MM - XXL MEGA TILES

XXL Mega — TILES

7 MM - REALISTIC STONE LOOK

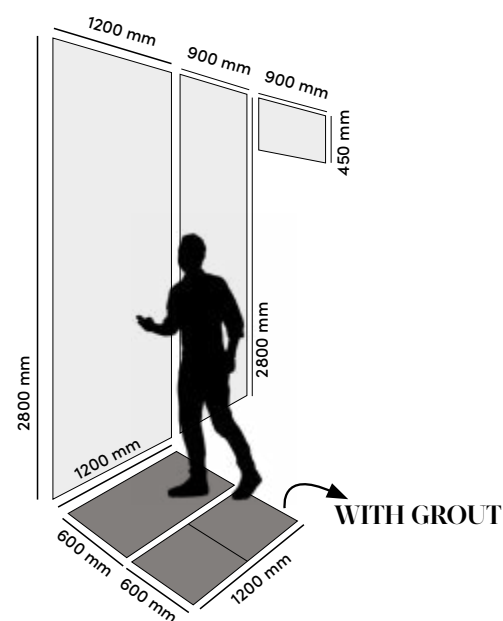

Total thickness of 7 mm - Wear layer of 0.55 mm and integrated backing. Dimensions: 600 x 1200 mm. Tiles available in 2 types: with or without grout. Grade: realistic stone look.

Épaisseur totale de 7 mm - Couche d'usure de 0,55 mm et sous-couche intégrée. Dalles disponibles en 2 types : avec ou sans joints. Dimensions: 600 x 1200 mm. Classe: aspect stone look.

Totale dikte van 7 mm - Slijtlaag van 0.55 mm en geïntegreerde ondervloer. Afmeting: 600 x 1200 mm. Tegels beschikbaar in 2 types: met of zonder voeg. Sortering: realistische stone look



TAGLIAMENTO - XXL MEGA TILES - GROUT

RENO



MINCIO

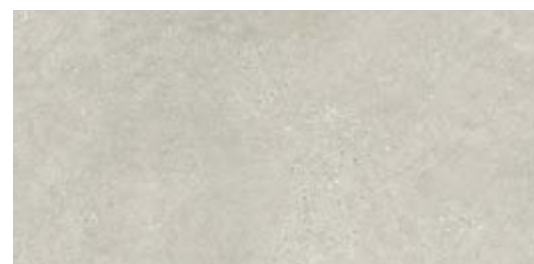

WHITE MARBLE



LIMESTONE

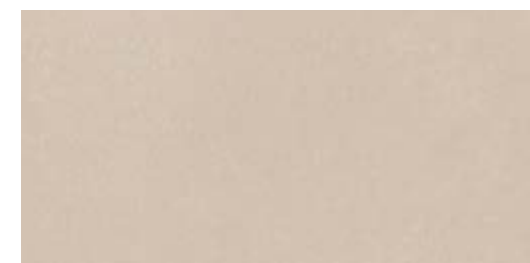

TAGLIAMENTO



SAVIO

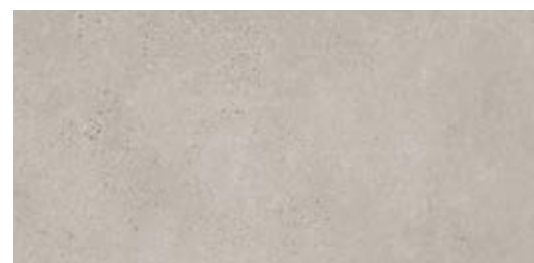

BLACK MARBLE



SANOMA



MATCHING & MEGA

XXL MEGA PANELS AND XXL MEGA TILES



RENO - XXL MEGA TILES



TILES & PANELS

SEE P. 60 FOR MATCHING XXL MEGA PANELS

MINCIO - XXL MEGA TILES

Rigid — WALLS

4,50 MM - STANDARD PANELS



MINCIO - STANDARD PANELS

Standard — PANELS

4,5 MM - REALISTIC STONE LOOK

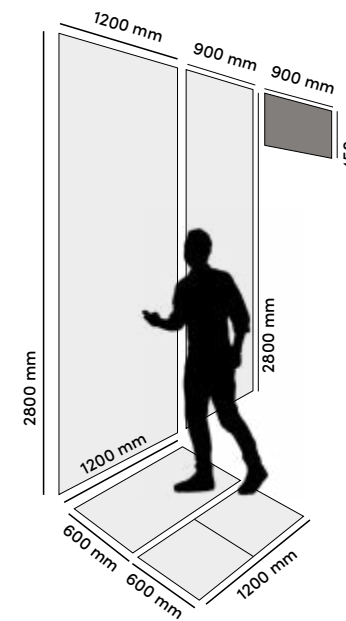

Total thickness of 4.5 mm -
Dimensions: 450 x 900mm. Water resistant.

Épaisseur totale de 4.5 mm -
Dimensions: 450 x 900 mm. Résistant à l'eau.

Totale dikte van 4.5 mm -
Afmeting: 450 x 900 mm. Waterwerend.

RENO



MINCIO

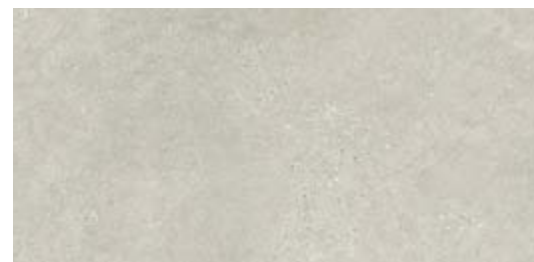

WHITE MARBLE

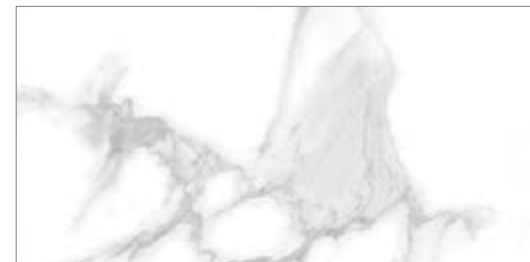

LIMESTONE

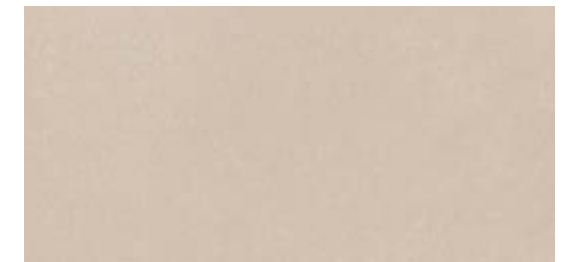

TAGLIAMENTO



SAVIO



BLACK MARBLE

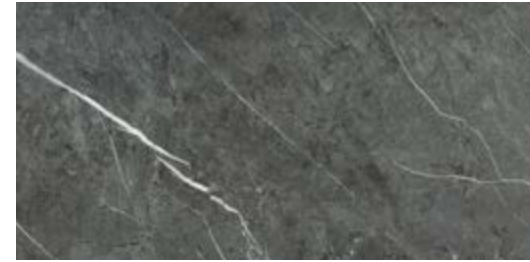

SANOMA

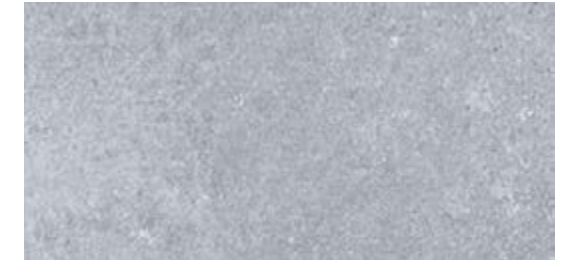

TAGLIAMENTO - STANDARD PANELS



AUTHENTIC
& REALISTIC

SAVIO - STANDARD PANELS

Rigid — WALLS

5 MM - MEGA PANELS

Mega — PANELS

5 MM - REALISTIC STONE LOOK

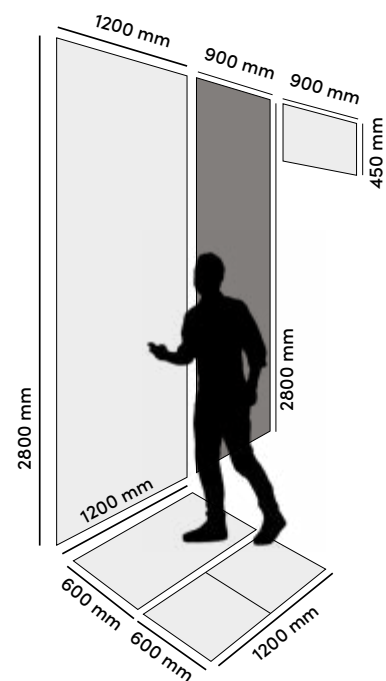

Total thickness of 5 mm.
Dimensions: 2800 x 900 mm - Water resistant.

Épaisseur totale de 5 mm.
Dimensions: 2800 x 900 mm - Résistant à l'eau.

Totale dikte van 5 mm.
Afmeting: 2800 x 900 mm - Waterwerend.

SNOW WHITE

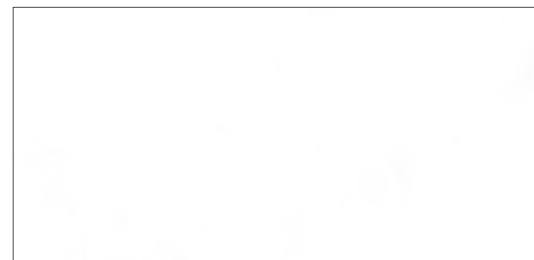

SNOW WHITE - MEGA PANELS

RENO



MINCIO

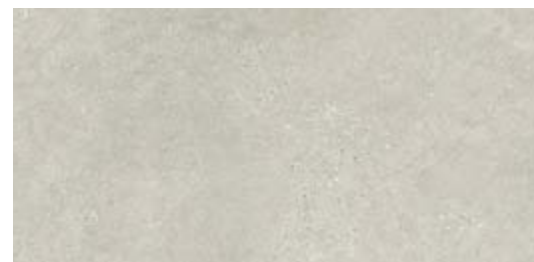

WHITE MARBLE

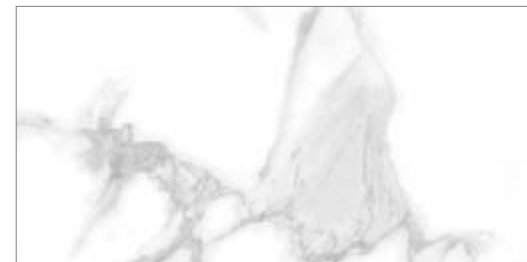

LIMESTONE

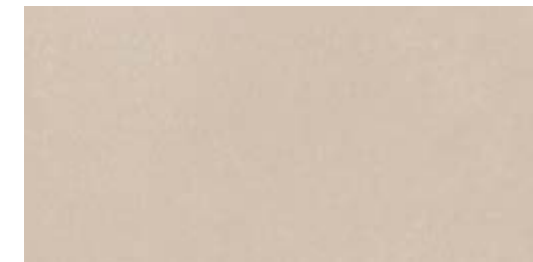

TAGLIAMENTO



SAVIO



BLACK MARBLE



SANOMA





LIMESTONE - MEGA PANELS



SANOMA - MEGA PANELS

Rigid — WALLS

4 MM - XXL MEGA PANELS

XXL Mega — PANELS

4 MM - REALISTIC STONE LOOK

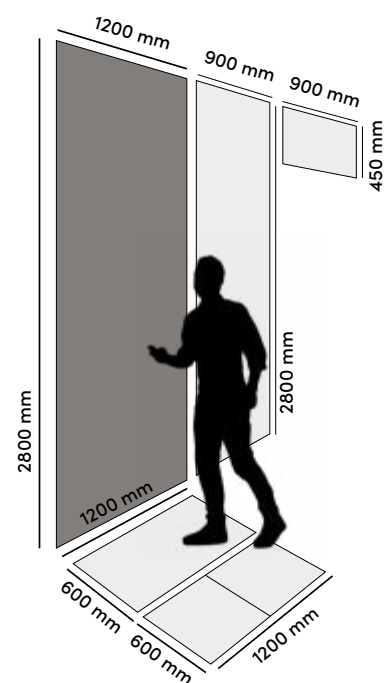

Total thickness of 4 mm.
Dimensions: 2800 x 1200 mm - Water resistant.

Épaisseur totale de 4 mm.
Dimensions: 2800 x 1200 mm - Résistant à l'eau.

Totale dikte van 4 mm.
Afmeting: 2800 x 1200 mm - Waterwerend.



RENO - XXL MEGA PANELS

RENO



MINCIO

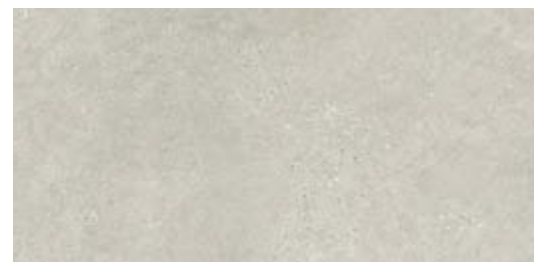

WHITE MARBLE

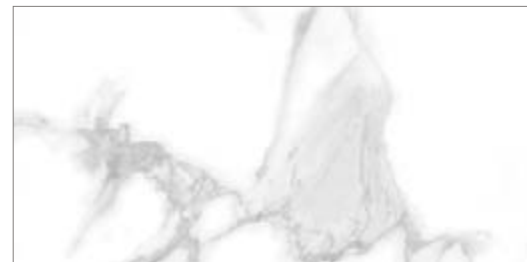

LIMESTONE

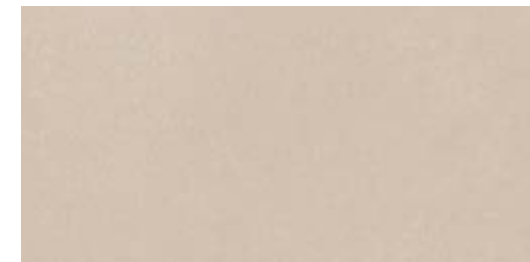

TAGLIAMENTO



SAVIO



BLACK MARBLE



SANOMA





MATCHING & MEGA

XXL MEGA PANELS - XXL MEGA TILES TAGLIAMENTO



MINCIO - XXL MEGA PANELS

Rigid

—TILES AND WALLS

OVERVIEW: EACH COLOR IN 5 OPTIONS

— Matching TILES & WALLS

EACH COLOR IN 5 OPTIONS

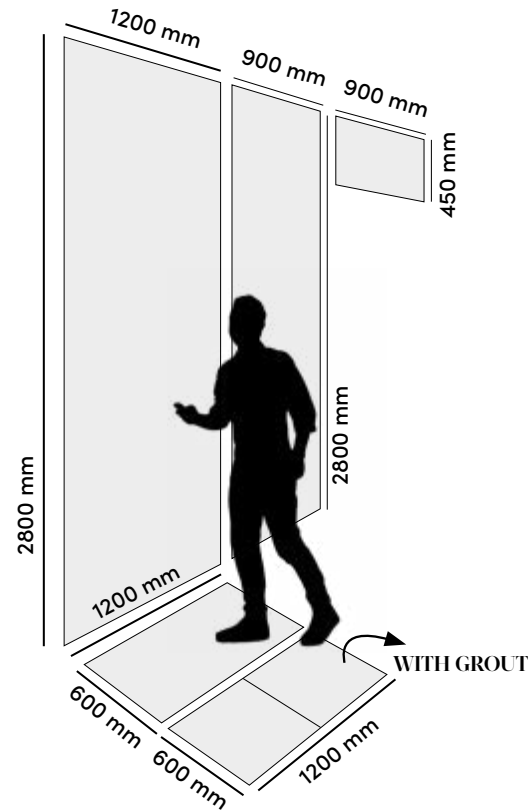

WALLS

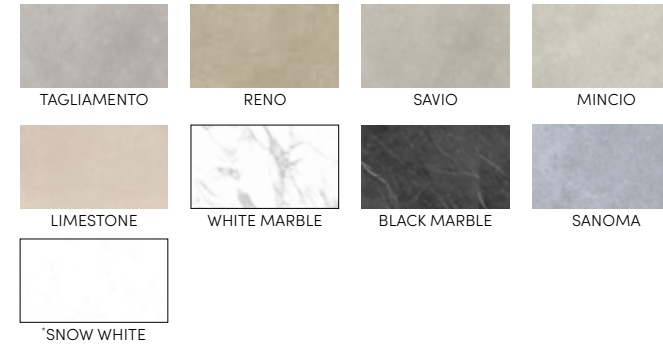

ITEM	DIMENSIONS
XXL MEGA PANELS	4,00 x 1200 x 2800 mm
MEGA PANELS	5,00 x 900 x 2800 mm
STANDARD PANELS	4,50 x 450 x 900 mm

*Snow white only available in Mega Panels 5,00 x 900 x 2800 mm

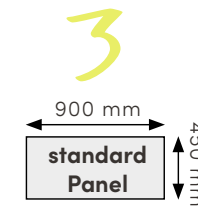
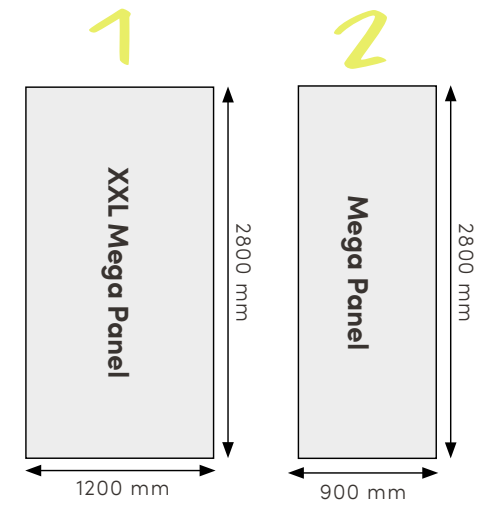

TILES



ITEM	WEAR LAYER	DIMENSIONS
XXL MEGA TILES	0.55 mm	7,00 x 600 x 1200 mm
XXL MEGA TILES - GROUT	0.55 mm	7,00 x 600 x 1200 mm

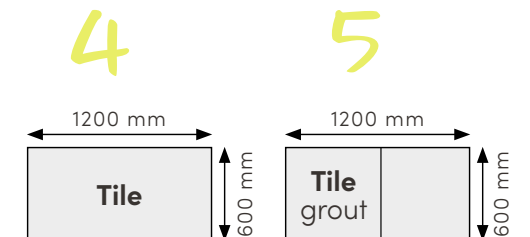

Rigid — ACCESSORIES

Rigid FLOORS

ACCESSORIES

1. MATCHING CLIC SKIRTINGS

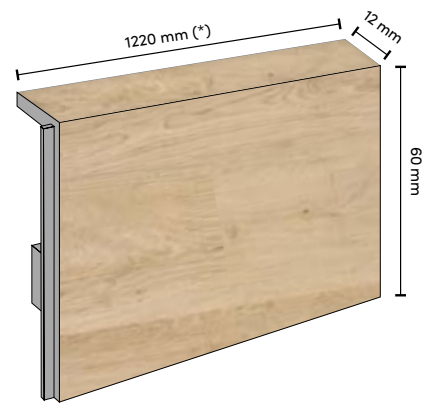

- Matching skirtings for the perfect finish of your floor.
- Plinthes assorties pour une finition optimale de votre sol.
- Bijpassende plinten voor een optimale afwerking van je vloer.

(* Each length corresponds to the length of the product.)

2. SKIRTING BOARD COVER - WITH T&G

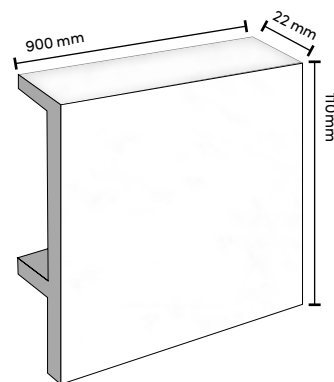

- A skirting board cover conceals existing skirting, allowing you to renovate quickly and neatly.
- Une plinthe de recouvrement couvre les plinthes existantes, vous permettant de rénover rapidement et proprement.
- Een overzetplint bedekt bestaande plinten, waardoor u snel en netjes kunt renoveren.

3. T-PROFILE

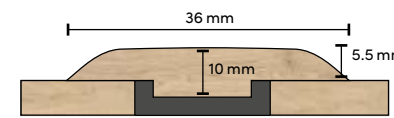

- Use a T-profile to make the transition between 2 floors of equal thickness.
- Utilisez un seuil en T pour assurer la liaison entre 2 sols de même épaisseur.
- Gebruik een T-profiel om de overgang tussen 2 vloeren met gelijke dikte op elkaar te laten aansluiten.

4. REDUCER-PROFILE

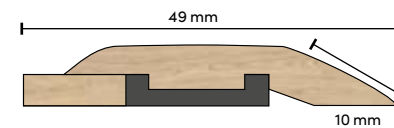

- Use a reducer profile to connect 2 floors of different heights.
- Utilisez un seuil-R pour raccorder 2 sols de différente épaisseur.
- Gebruik een R-profiel om 2 vloeren met verschillende hoogte op elkaar te laten aansluiten.

5. STAIR TREAD WITH NOSING

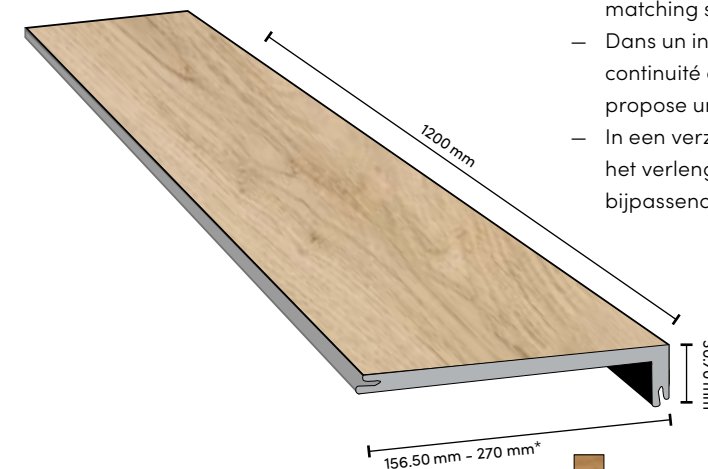

- In a nicely designed interior, the finish of the stairs acts as an extension of the floor. That's why Rigid Floors provides a matching stair tread with nosing.
- Dans un intérieur soigné, la finition de l'escalier s'inscrit en continuité avec celle du plancher. Voilà pourquoi Rigid Floors propose une marche d'escalier assortie avec nez.
- In een verzorgd interieur is de afwerking van de trap als het verlengde van de vloer. Daarom voorziet Rigid Floors bijpassend traptrede met neus.

Rigid — CARE

REGULAR MAINTENANCE FOR RIGID FLOORS

1. RIGID CARE

For regular maintenance of your Rigid Floor: Mix 100 ml of Rigid Care for every 10 liters of lukewarm water. Clean the floor with a well-wrung mop or microfiber cloth. Rinse the mop/ microfiber cloth regularly and wring it out well. Let the floor dry without rinsing.

Pour l'entretien régulier de votre Rigid Floor: Mélangez 100 ml de Rigid Care pour 10 litres d'eau tiède. Nettoyezle sol avec une vadrouille bien essorée ou un chiffon en microfibre. Rincez régulièrement la serpillière/chiffon en microfibre et essorez-la bien. Laissez sécher le sol sans rincer.

Voor het algemene onderhoud van uw Rigid Floor: Meng 100 ml Rigid Care voor elke 10 liter lauw water. Reinig de vloer met een goed uitgewrongen dweil of microvezeldoek. Spoel de dweil/microvezeldoek regelmatig uit en wring deze goed uit. Laat de vloer drogen zonder te spoelen



Rigid WALLS — ACCESSORIES

1. OUTSIDE PROFILE

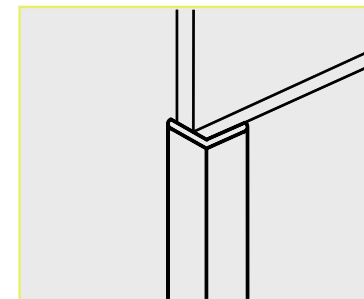

- Aluminum profile for finishing an outside corner.
- Profilé en aluminium pour la finition d'un angle extérieur.
- Aluminium afwerkingsprofiel voor de afwerking van een buitenhoek.

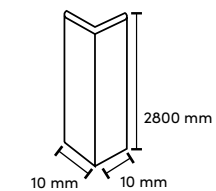
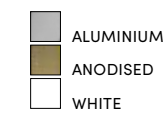

2. INSIDE PROFILE

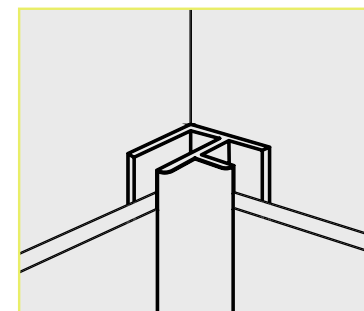

- Aluminum profile for finishing inside corners.
- Profilé en aluminium pour la finition des angles intérieurs.
- Profiel in aluminium voor de afwerking van binnenhoeken.

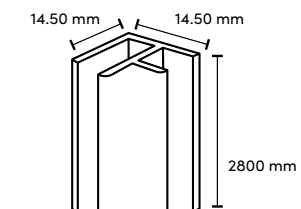
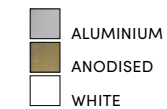

3. END PROFILE

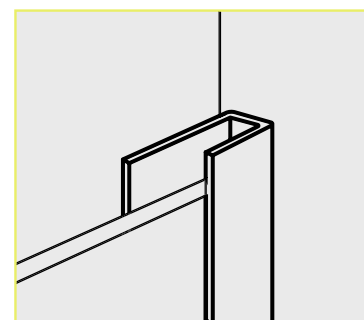



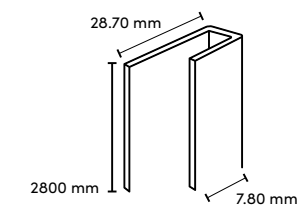

- Aluminum finishing profile for edging wall panels.
- Profilé de finition en aluminium pour bordures de panneaux muraux.
- Aluminium afwerkingsprofiel voor het afboorden van wandpanelen.





Technical — INFORMATION

Rigid — FLOORS

Essential requirements	NORM	2,50 mm	5 mm	6,50 mm	7 mm	8 mm
 SLIP RESISTANCE*	EN 13893:2003 / BS 7976-2:2002	R9	R9	R9	R9	R9
 REACTION TO FIRE	EN 13501-1:2019	B _{fl} s1	B _{fl} s1	B _{fl} s1	B _{fl} s1	B _{fl} s1
 FORMALDEHYDE	EN 717-1:2004	E1	E1	E1	E1	E1
 PCP	EN 12673:1999	ND	ND	ND	ND	ND
CLASS OF USE	EN ISO 10874	33	33	42	33	42

Rigid — WALLS

Essential requirements	NORM	4 mm	4.5 mm	5 mm
 REACTION TO FIRE	EN 13501-1	C-s3	C-s3	C-s3
 FORMALDEHYDE	EN 12149-C	E1	E1	E1
HEAVY METALS	EN 12149-A	Pass	Pass	Pass
RELEASE VCM	EN 12149-B	Pass	Pass	Pass



The information provided in this catalog has been compiled with care. However, Rigid Floors cannot guarantee the correctness or completeness of the information. The information provided is not legally binding.

Les informations fournies dans ce catalogue ont été compilées avec soin. Cependant, Rigid Floors ne peut garantir l'exactitude ou l'exhaustivité des informations. Les informations fournies ne sont pas juridiquement contraignantes.

De in deze catalogus verstrekte informatie is met zorg samengesteld. Toch kan Rigid Floors niet instaan voor de juistheid of volledigheid van de informatie. Aan de verstrekte informatie kunnen geen rechten worden ontleend.

Rigid
— FLOORS
& WALLS

by lalegno 